

NURO7/CM



POWERED BY ILLUMUS. BRANDS

Bluetooth Ceiling Mount Dual Mode Sensor

FEATURES

- Ceiling Mount Bluetooth Groupable Sensor designed for Room Control
 - Dual-tech PIR Motion Sensing + Ultrasonic technology
 - Occupancy/Vacancy Sensing
 - Hold Time
 - Standby Time/Level
 - High/Low End Trim
 - Background Light Level
 - Groupable
 - Zoning
 - Scheduling
- Compatible with Wireless & Wired Wall Switches
- Easily Controlled via Mobile Phone or Tablet with NUROAir app
- Available on iOS and Google Play Stores

LEARN MORE
BY VISITING
OUR WEBSITE



SCAN OR
CLICK HERE



DIGITAL NAVIGATION

Explore the spec sheet through the links below

COMPATIBLE FIXTURES	SUITABLE APPLICATIONS
DEFAULT FACTORY SETTINGS	BUTTON CONFIGURATIONS
RESTORE FACTORY SETTINGS	LINE DRAWINGS
SENSOR COVERAGE PATTERN	WIRING DIAGRAM
APP DOWNLOAD	

SPECIFICATIONS: NURO7/CM

Input Voltage	120-277VAC	Radio Frequency	2.4GHz ± 75MHz	Operating Temperature	0°C to 55°C, 32°F to 131°F
Frequency	50/60Hz	Bluetooth Version	5	IP Rating	IP20
Output Current	6A Max	Housing Material	UL 94-5VA	Color	White
Sinking Current	48.5mA	Detection Range	32ft Max	Warranty	5 year warranty
Max Load	800W Max	Mounting Height	Up to 10ft	Compliance	UL Listed LED Controller FCC ID: 2BLDONUROSTLIA
Bluetooth Transmit	100ft Max	Location	Indoor use only		

COMPATIBLE FIXTURES

- All NUROAir Compatible Fixtures

SUITABLE APPLICATIONS

- Schools
- Offices
- Auditoriums
- Warehouses
- Healthcare
- Retail

DEFAULT FACTORY SETTINGS

PIR Sensitivity = High	Hold Time = 20 min	Triggered by = PIR or Ultrasonic
Ultrasonic Sensitivity = Medium	Standby Time = 1 min	Hold on by = PIR or Ultrasonic

Bluetooth Ceiling Mount Dual Mode Sensor

BUTTON CONFIGURATIONS

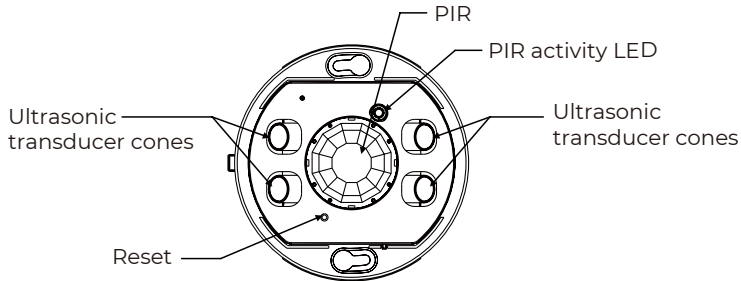

Pairing

NURO7/CM will start pairing mode once it is connected to power if not paired.

LED Indicator

The indicator flashes in two colors, blue and green.
Blue: Triggered by PIR signal.
Green: Triggered by ultrasonic signal.

RESTORE FACTORY SETTINGS

In the event that the sensor does not appear on the Switches page of the app, it may have been previously assigned to another zone. To resolve this, please follow the steps below to restore the sensor(s) to the factory settings.

Option 1

The simplest approach is to remove the sensor from the app on the Switches page.

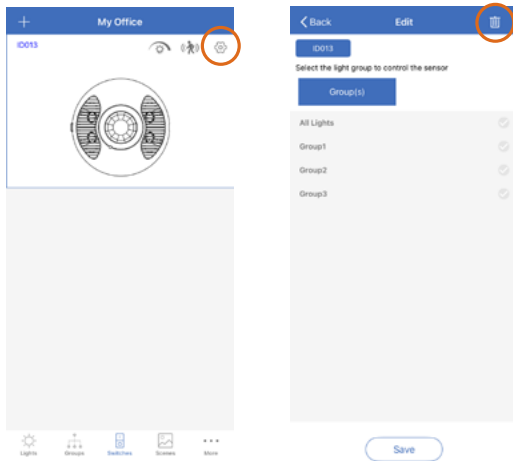

Option 2

Follow the below power reset sequence to restore factory settings.

1. Confirm all sensors are off.
2. Turn on sensors for 8 seconds; then turn the power off for 10 seconds.
3. Immediately turn the sensors on and off, then wait for another 10 seconds. Repeat 3 times.
4. Turn the sensors on for 8 seconds, then turn the power off for another 10 seconds. Repeat 2 times.
5. Turn the sensors back on. All previous settings and data for these lights have now been deleted.

Option 3

1. Reset button is behind the face plate, remove the plate to find it.
2. Press the reset button for 3 seconds to reset the NURO7/CM to factory setting.
3. After reset, the indicator will flash blue quickly and you may pair it with the app within 30 seconds.

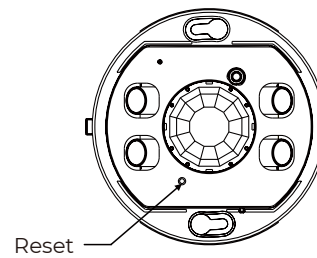

Bluetooth Ceiling Mount Dual Mode Sensor

FEATURES BREAKDOWN

Dual-tech PIR Motion Sensing + Ultrasonic technology

Dual-tech PIR Motion Sensing + Ultrasonic technology combines two different types of motion-sensing technologies to enhance accuracy and reduce false triggers. With this function enabled, the light can be automatically turned on when detecting motion, and dimmed or turned off when no motion detected, according to the preset Mode, Hold Time, Standby Time and Standby Level applied.

Occupancy/Vacancy Sensing

Occupancy Sensing: Lights will automatically turn on when motion is detected and turn off when no motion is detected after the preset Standby Time.

Vacancy Sensing: Lights will automatically turn off when no motion is detected after the preset Standby Time. They can only be turned back on manually and will not be triggered by motion detection.

Hold Time

Adjusts the duration that lights remain on after motion is detected, before taking a secondary action such as dimming or turning off the lights.

Standby Time/Level

Standby Time begins after the Hold Time elapses without detecting motion. During Standby Time, the lights will dim to the specified Standby Level and will turn off once Standby Time ends. The Standby Level represents the percentage of the Auto Mode Level to which the lights are dimmed during Standby Time.

Auto Mode: Lights with motion, daylight harvesting or photocell sensor connected and enabled can be automatically turned on/off or dimmed up/down in Auto Mode according to the settings applied. Lights in Auto Mode have a letter A in the center of their icons on the app. The preset level of brightness/color is Auto Mode Level.

High/Low End Trim

Enables adjustment of maximum and minimum brightness to create a customized lighting experience. Automated high and low-end trim levels can be programmed in the app to activate automatically when motion is detected (High End Trim) or once the Standby Time/Level has elapsed (Low End Trim).

Background Light Level

When Background Light is enabled for a group, lights that have not directly detected motion will adjust to a specified percentage of the Auto Mode Level after Hold Time if another light in the same group detects motion. This specified percentage of Auto Mode Level is Background Light Level. The lights not directly detecting motion will be triggered back to the Background Light Level when another light in the same group directly detects motion. Background Light Level will override Standby Level previously set.

Groupable

Once lights are added to a zone, a group called "All Lights" will be automatically created, containing all the lights in that zone. Lights within the same group can be adjusted collectively, including settings like brightness and color. For more accurate color tuning, it is recommended to create groups with lights that share similar CCT ranges. A single light can be a member of up to 20 different groups. Each group can support up to 100 lights..

Zoning

Each zone is a separate lighting control mesh system that includes all associated lights, groups, switches, scenes, and schedules. A single zone can accommodate up to 100 lights, 32 switches, 127 scenes, and 32 schedules. For larger installations, multiple zones can be created. The number of zones is unlimited with the NUROAir lighting control system.

Bluetooth Ceiling Mount Dual Mode Sensor

FEATURES BREAKDOWN

Scheduling

A schedule consists of one-time or recurring commands that instruct specific lights to perform a selected action at a preset time. Schedules can be applied to individual lights, groups, or scenes. For easy recognition across different pages of the app, it is recommended to keep schedule names within 6 characters.

Wireless & Wired Wall Switches

NUROAir switches can be added to the system on the app and associated with lights for easy control. Each zone can contain up to 32 switches. One switch can be associated with one light or one group only in the zone. Add more switches to control multiple Lights or Groups separately. Note: Do not add the same switch to different zones to ensure proper working of the switch. Remove it from the previous zone first if need to add to another zone.

LINE DRAWINGS

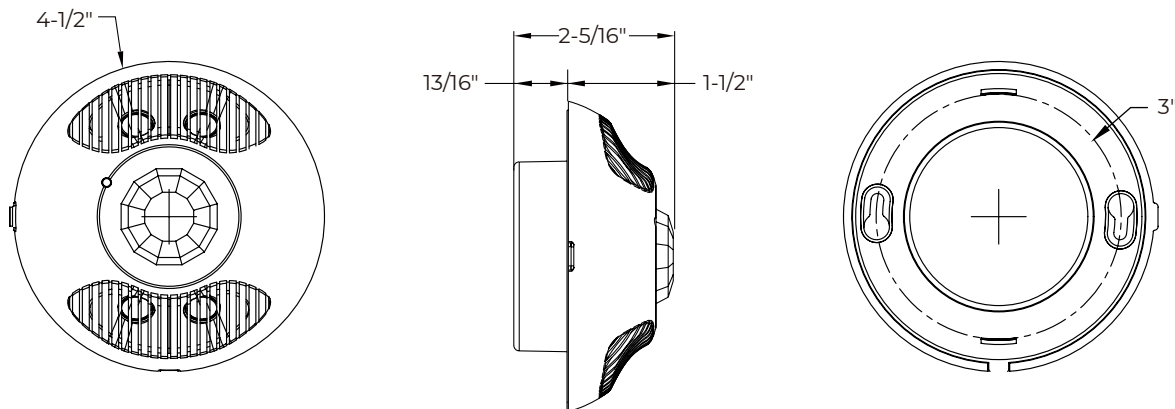

SENSOR COVERAGE PATTERN

PIR Coverage Top View

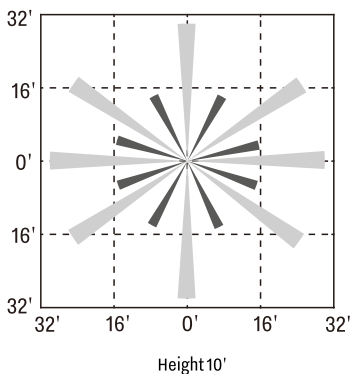

PIR Coverage Side View

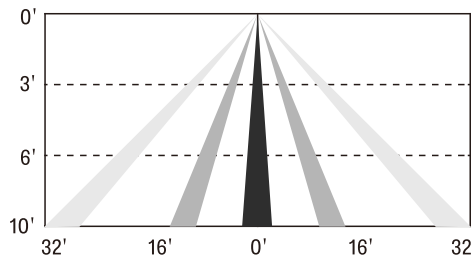

PIR+Ultrasonic Coverage Top View

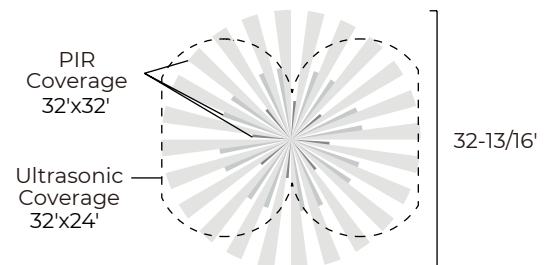

NURO7/CM

Bluetooth Ceiling Mount Dual Mode Sensor

WIRING DIAGRAM

Compatible with NUROAir powered lighting fixtures through wireless Bluetooth connection

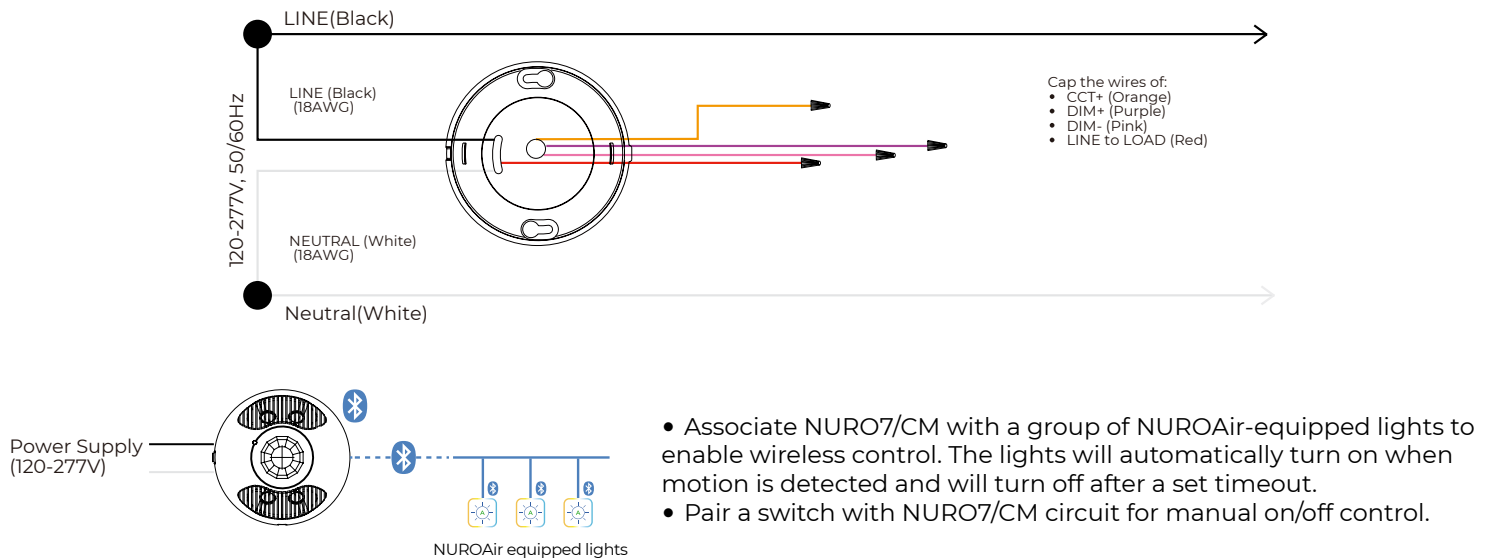

APP DOWNLOAD



Note: All rights reserved. All sizes and specifications are subject to change at any time without notice.